



ASML



MTC 2024 – Being Part of the Progress Design Teams & Suppliers

Firat Buyukcivelek
MDEV Architect NXT WS & Competence Lead TC-049 DfX - DfMA

April 16, 2024
Veldhoven
CREATION DATE: 2024-03-17

00





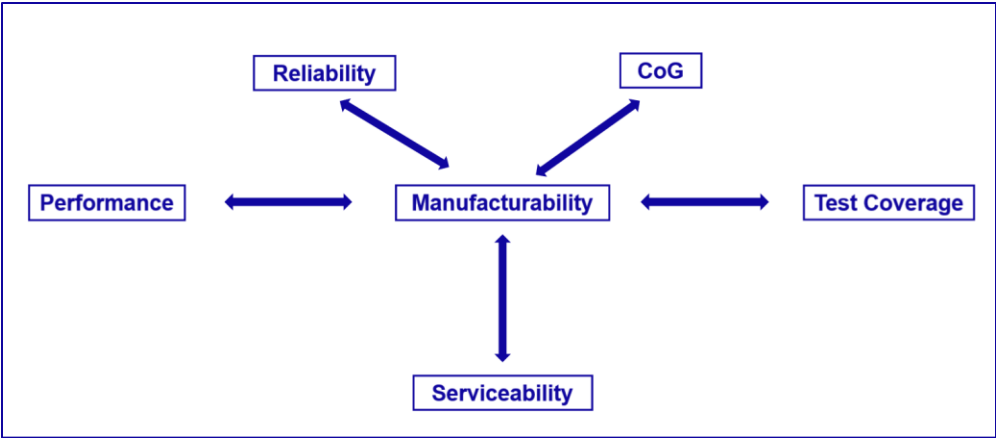
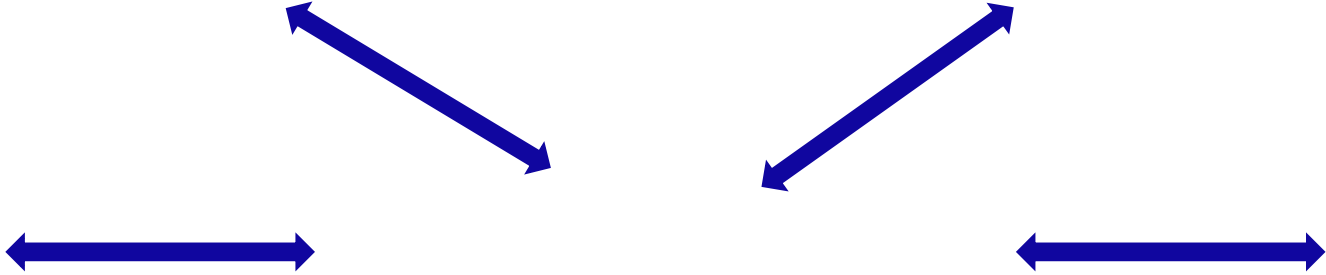

Being Part of the Progress



We care

We act with integrity, respecting people, society and the planet. We take responsibility to create a safe, inclusive and trusting environment for everyone.



We collaborate

We collaborate to tap into our collective potential. We work together with our stakeholders to create the best solutions for ASML as a whole.



We challenge

Say it can't be done, we dare you. We eagerly refine our ideas and processes, pushing technology and results to new limits.

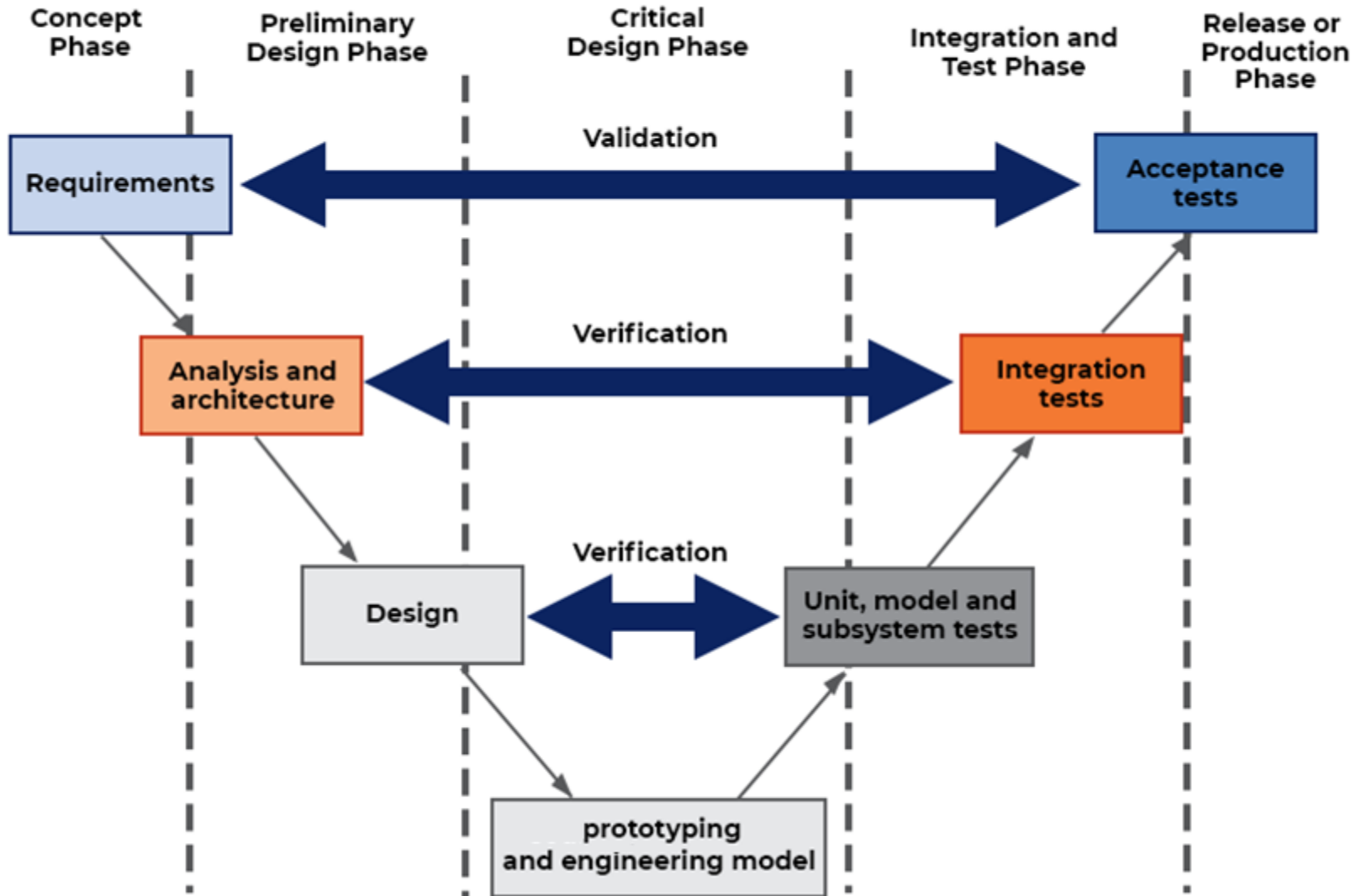

How to manufacture?

Defectivity, cost, performance, availability...

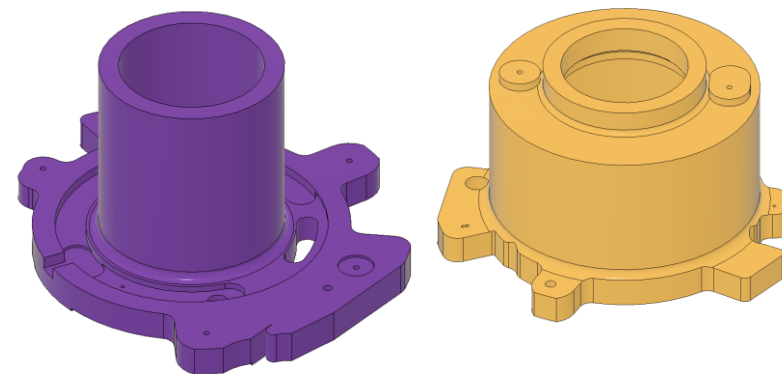

How to measure?

Jigs, # of measurements, how to measure in detail?

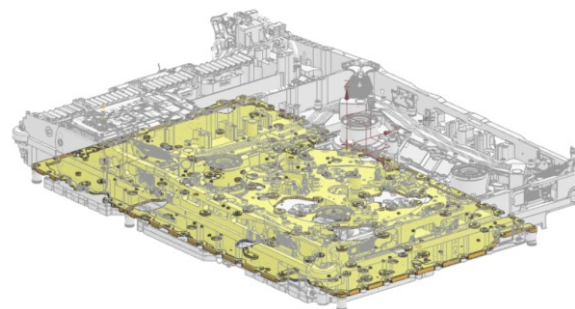
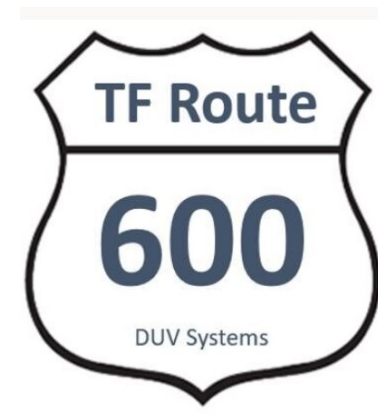

Challenge

Pro-active Communication

Requirements, Materials, Processes...

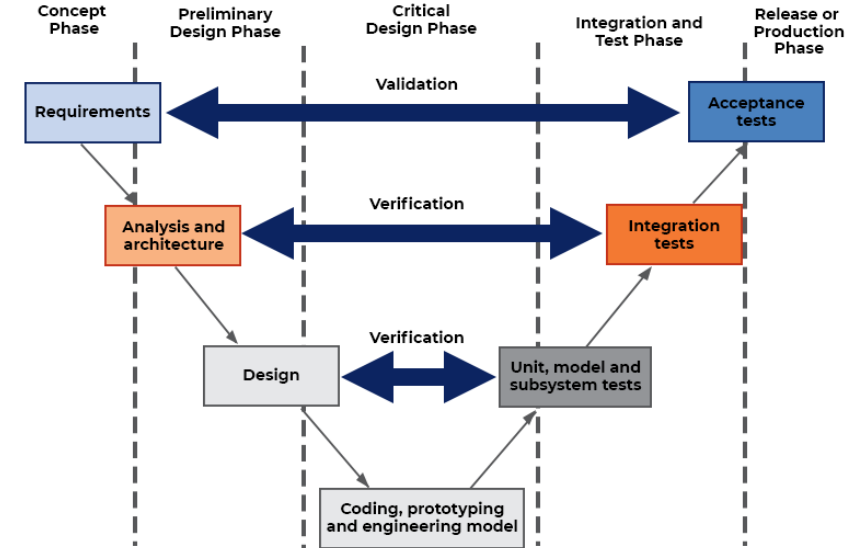

Knowledge Sharing!

Expertise, From feasibility phase to series production...



Care

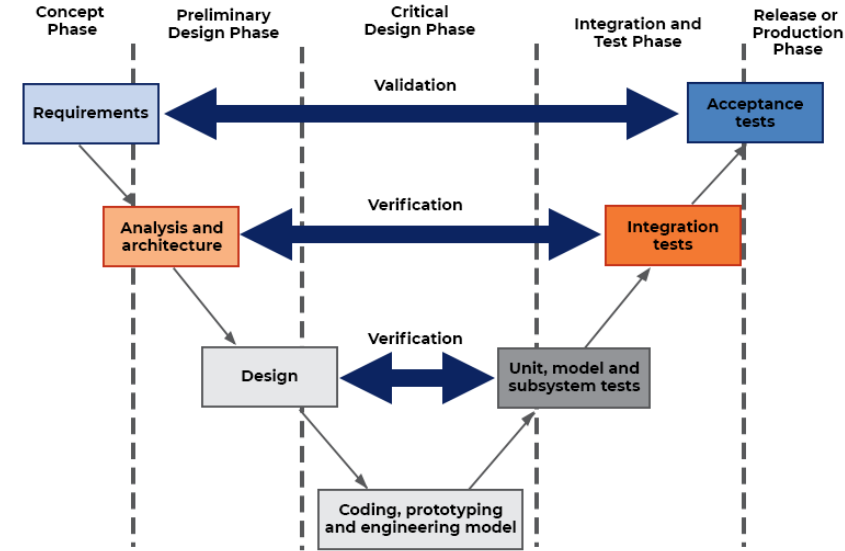

We enable each other to make it together!

8D reporting, TPD Maintenance, DNs, MNs, Lessons Learned

Everyone does his job at his best!

We are on the same side same boat!

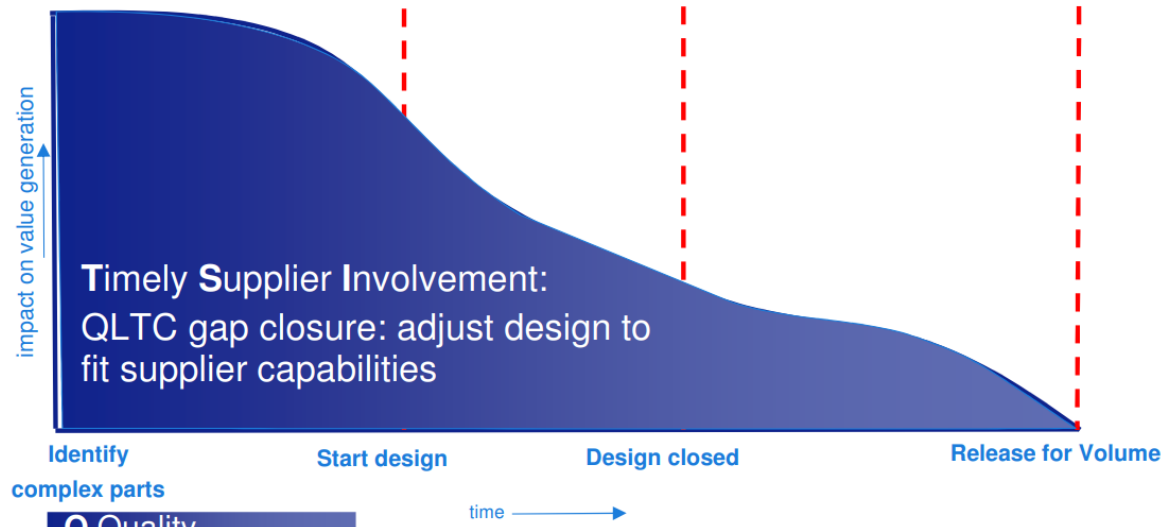

- Q** Quality
- L** Logistics
- T** Technology
- C** total Costs

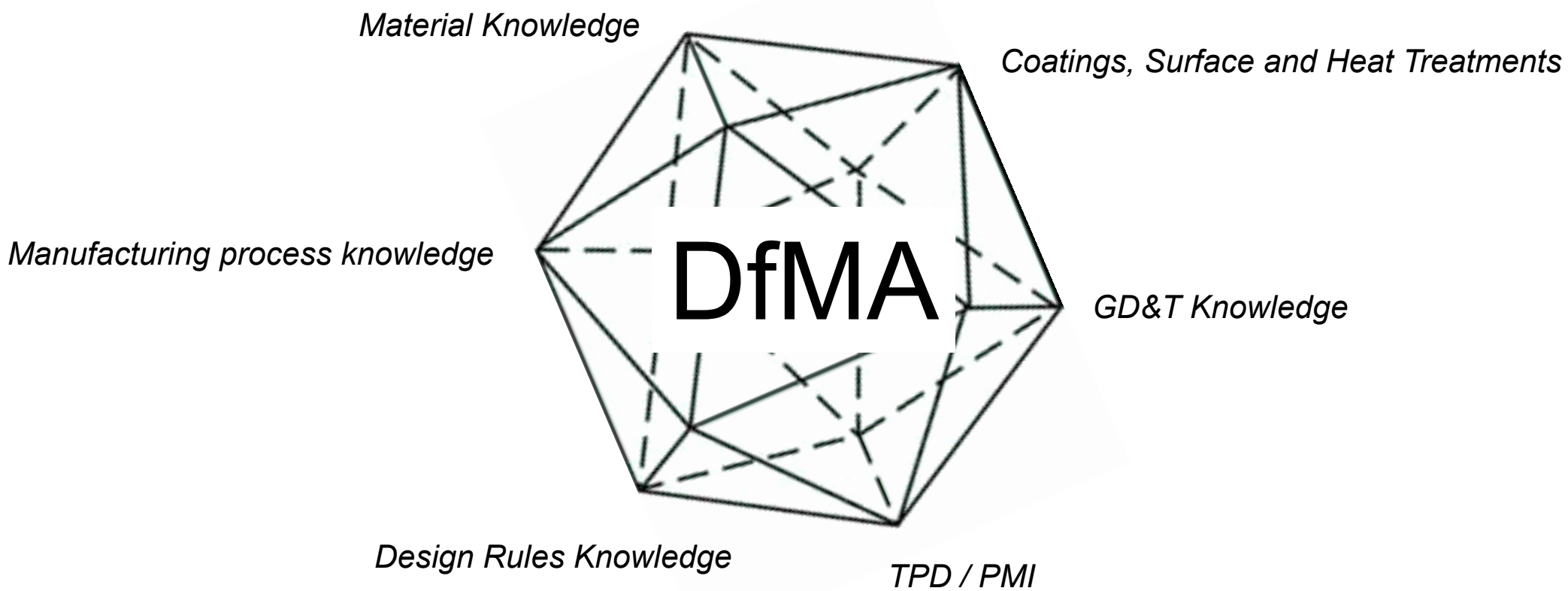

Thank You!

*"Alone we can do so little;
together we can do so much..."*

ASML



Firat Buyukcivelek
MDEV Arch / Competence Lead

+31 611840586
firat.buyukcivelek@asml.com



Veldhoven